

CIRCLE 60/80

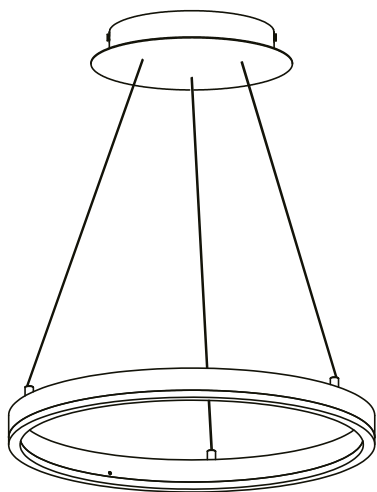

The installation may only be carried out by a technician
Nur ein Techniker kann die Installation durchführen

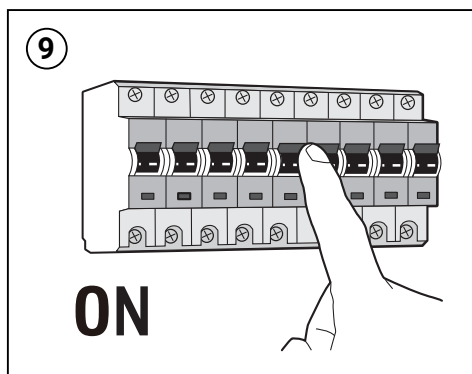

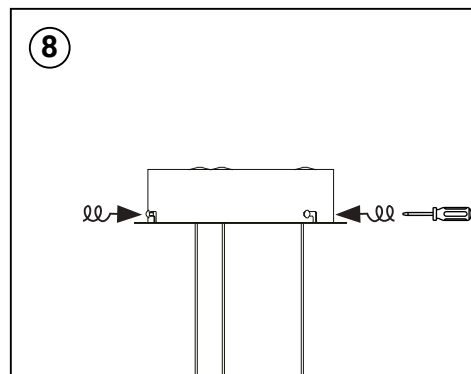
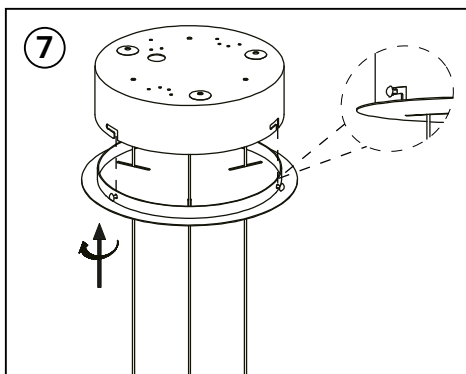
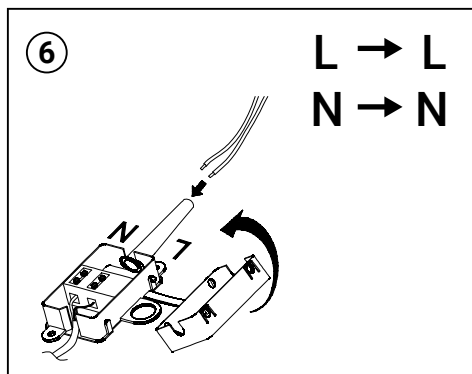
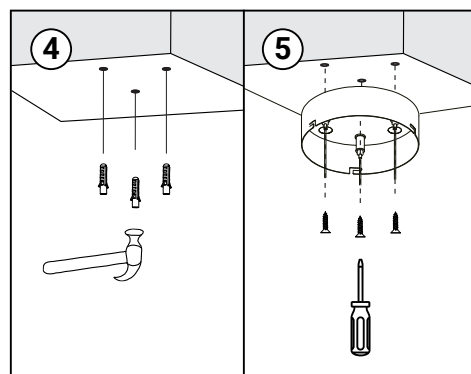
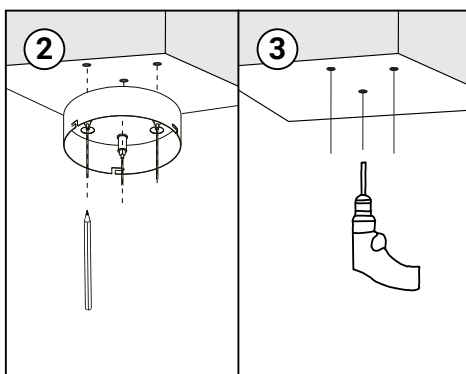
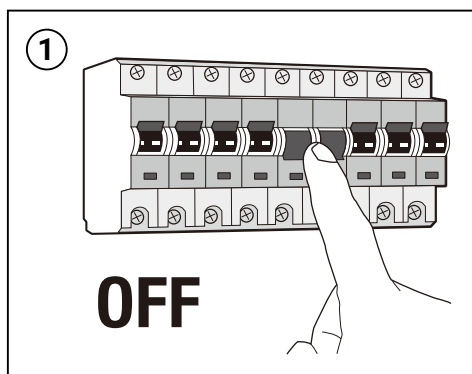
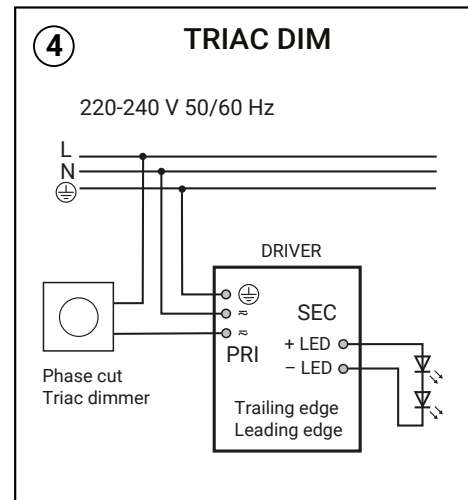
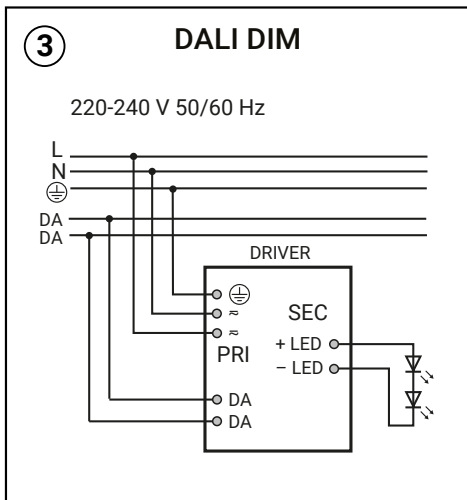
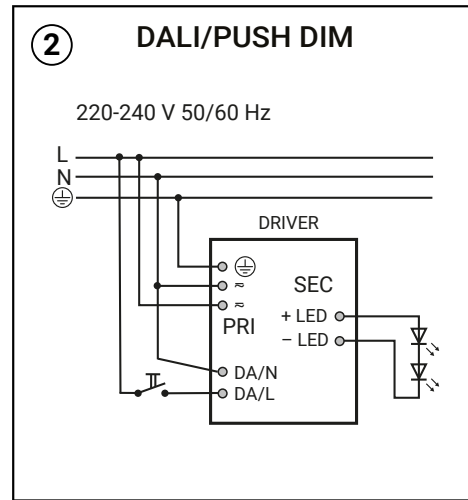
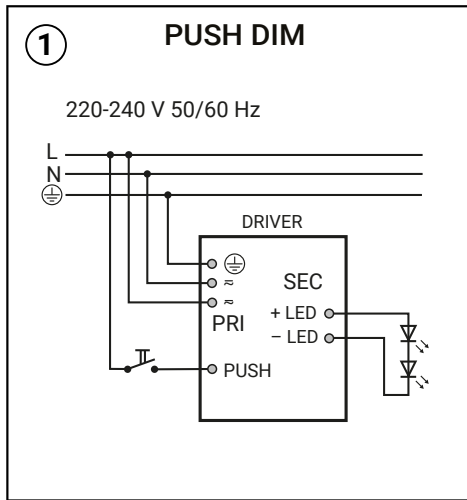

(EN) CAUTION!

Turn off the main power before proceeding with the installation in order to prevent possible shock. The installation may only be carried out by a technician or a qualified person. If the lamp has a lampshade/diffuser, handle it carefully as it is fragile. With an integrated LED light source, only a technician or a qualified person can make the replacement. The manufacturer is not responsible for the incorrect use and assembly of its products.

(DE) ACHTUNG!

Vor der Installation ist es notwendig, den Hauptstromkreis zu unterbrechen, um ein Stromschlag zu vermeiden. Die Installation darf nur von einem Techniker oder einer qualifizierten Person durchgeführt werden. Wenn die Lampe einen Lampenschirm/Diffuser hat, gehen Sie vorsichtig damit um, da sie zerbrechlich ist. Mit einer integrierten LED-Lichtquelle kann nur ein Techniker oder eine qualifizierte Person den Austausch vornehmen. Der Hersteller ist nicht verantwortlich für die fehlerhafte Verwendung und Montage seiner Produkte.